

Features

- $V_{DS}=40V, I_D=78A$
 $R_{ds(on)}(typ)=6m\Omega@V_{gs}=4.5V$
 $R_{ds(on)}(typ)=4.8m\Omega@V_{gs}=10V$
- 100% Avalanche Tested
- 100% Rg Tested
- Lead-Free (RoHS Compliant)

Applications

- DC Motor Control
- DC-DC Converters
- BMS
- SMPS
- Automotive Environment

Internal Circuit and Pin Description

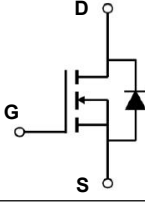
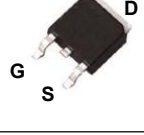
	
Package	TO-252
Package Code	M

Package Marking

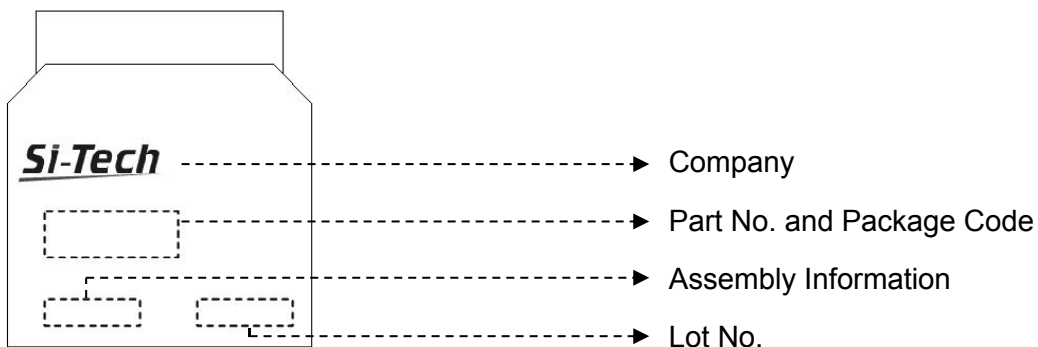

Absolute Maximum Ratings ($T_C=25^{\circ}C$ unless otherwise noted)

Symbol	Parameter	Value	Units
V_{DSS}	Drain-Source Voltage	40	V
I_D	Continuous Drain Current ($T_C=25^{\circ}C$)	78	A
	Continuous Drain Current ($T_C=100^{\circ}C$)	49	A
I_{DM}	Pulsed Drain Current (Note 1)	312	A
V_{GS}	Gate-Source Voltage	± 20	V
E_{AS}	Single Pulsed Avalanche Energy (Note 2)	182	mJ
P_D	Maximum Power Dissipation ($T_C=25^{\circ}C$)	68	W
	Derating Factor above $25^{\circ}C$	0.54	W/ $^{\circ}C$
T_J	Operating Junction Temperature Range	-55 to +150	$^{\circ}C$
T_{STG}	Storage Temperature Range	-55 to +150	$^{\circ}C$

Thermal Characteristics

Symbol	Parameter	Value	Units
$R_{th\ j-c}$	Thermal Resistance, Junction to case	1.82	$^{\circ}C/W$

Electrical Characteristics ($T_c=25^{\circ}C$ unless otherwise noted)

Symbol	Parameter	Test Conditions	Min.	Typ.	Max.	Units
BV_{DSS}	Drain-Source Breakdown Voltage	$V_{GS}=0V, I_D=250\mu A$	40	-	-	V
I_{DSS}	Drain-Source Leakage Current	$V_{DS}=38V, V_{GS}=0V$	-	-	1	μA
I_{GSS}	Gate Leakage Current, Forward	$V_{GS}=20V, V_{DS}=0V$	-	-	100	nA
	Gate Leakage Current, Reverse	$V_{GS}=-20V, V_{DS}=0V$	-	-	-100	nA
$V_{GS(th)}$	Gate Threshold Voltage	$V_{GS}=V_{DS}, I_D=250\mu A$	1.5	2	2.5	V
$R_{DS(on)}$	Drain-Source On-State Resistance	$V_{GS}=4.5V, I_D=40A$	4.8	6	7.2	$m\Omega$
		$V_{GS}=10V, I_D=40A$	3.8	4.8	5.5	$m\Omega$
Q_g	Total Gate Charge	$V_{DD}=30V$	-	44	-	nC
Q_{gs}	Gate-Source Charge	$V_{GS}=4.5V$	-	11	-	nC
Q_{gd}	Gate-Drain Charge	$I_D=40A$ (Note 3)	-	19	-	nC
$t_{d(on)}$	Turn-on Delay Time	$V_{DD}=37.5V, V_{GS}=10V$	-	22	-	ns
t_r	Turn-on Rise Time	$I_D=45A, R_G=4.7\Omega$	-	31	-	ns
$t_{d(off)}$	Turn-off Delay Time	$T_c=25^{\circ}C$	-	74	-	ns
t_f	Turn-off Fall Time	(Note 3)	-	42	-	ns
R_g	Gate Resistance	$V_{DS}=0V, V_{GS}=0V, f=1MHz$	-	1.9	-	Ω
C_{iss}	Input Capacitance	$V_{DS}=25V$	-	2129	-	pF
C_{oss}	Output Capacitance	$V_{GS}=0V$	-	279	-	pF
C_{rss}	Reverse Transfer Capacitance	$f = 1MHz$	-	166	-	pF

Source-Drain Diode Characteristics ($T_c=25^{\circ}C$ unless otherwise noted)

Symbol	Parameter	Test Conditions	Min.	Typ.	Max.	Units
I_S	Continuous Source Diode Forward Current		-	-	78	A
I_{SM}	Pulsed Source Diode Forward Current (Note 1)		-	-	312	A
V_{SD}	Forward On Voltage	$V_{GS}=0V, I_S=45A$	-	0.9	1	V
t_{rr}	Reverse Recovery Time	$V_{GS}=0V, I_S=45A$	-	41	-	ns
Q_{rr}	Reverse Recovery Charge	$dI_F/dt = 100A/\mu s$	-	72	-	nC

Notes:

1. Repetitive Rating: Pulse width limited by maximum junction temperature
2. $L=0.5mH, V_{DD}=36V, R_G=25\Omega$, Starting $T_J=25^{\circ}C$
3. Pulse Width $\leq 300\ \mu s$; Duty Cycle $\leq 2\%$

Typical Characteristics

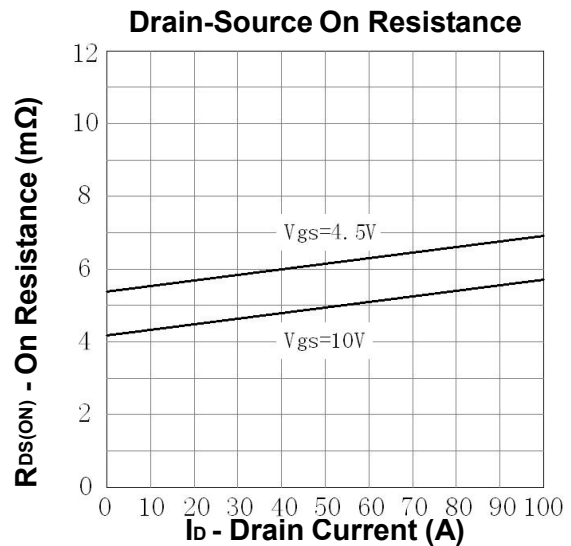
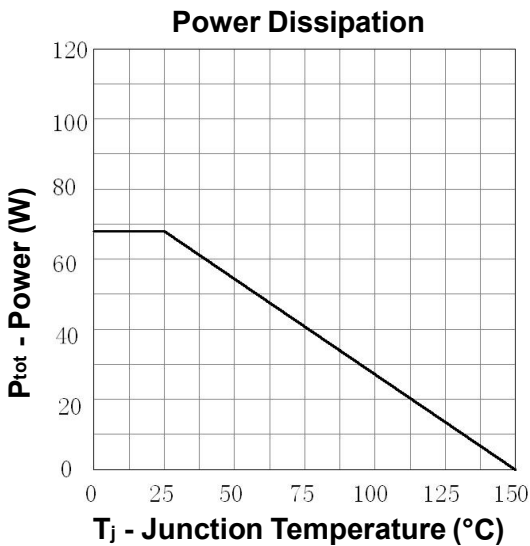
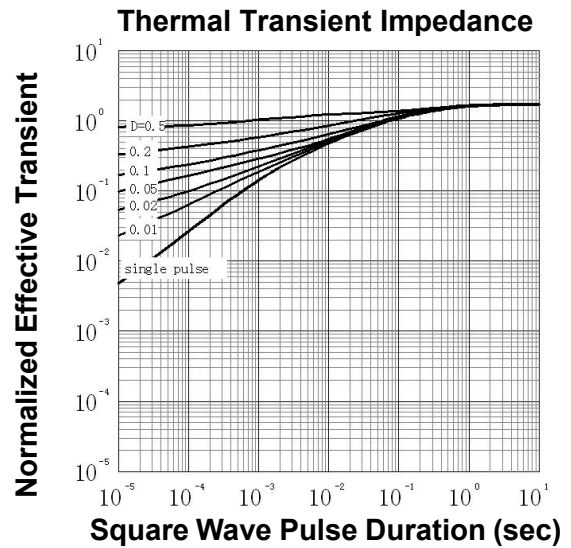
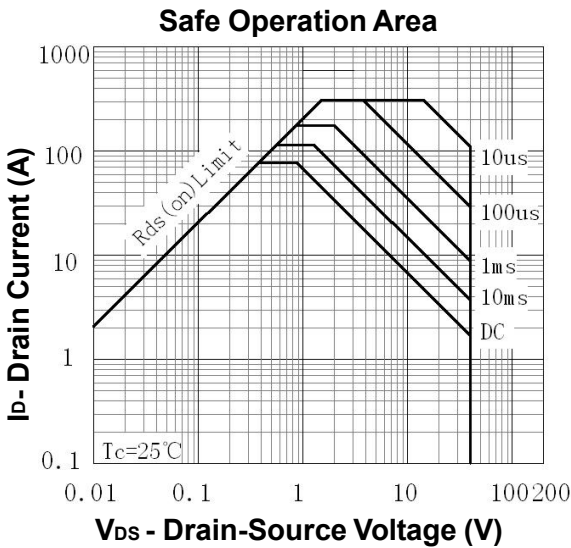
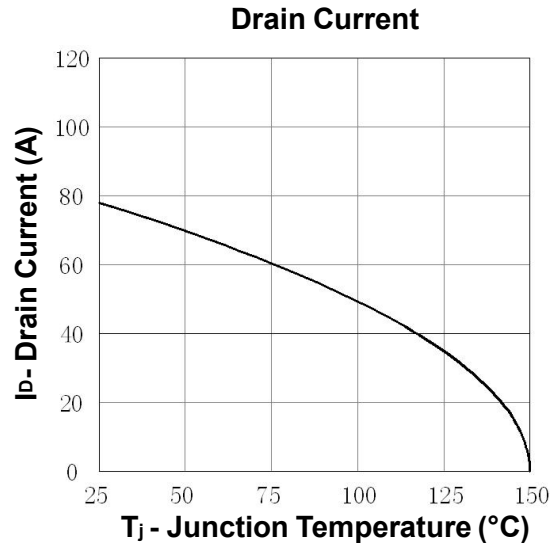
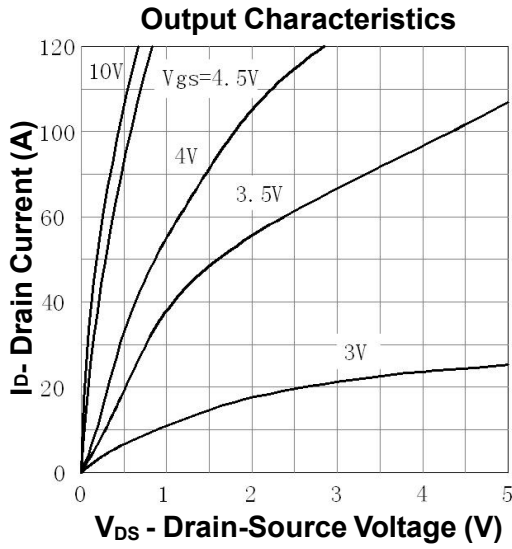

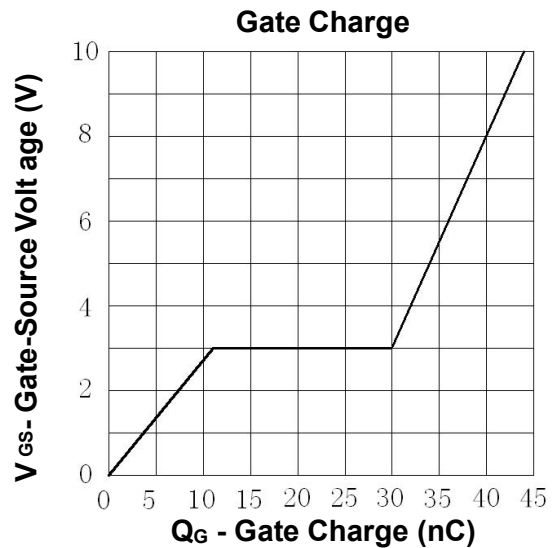
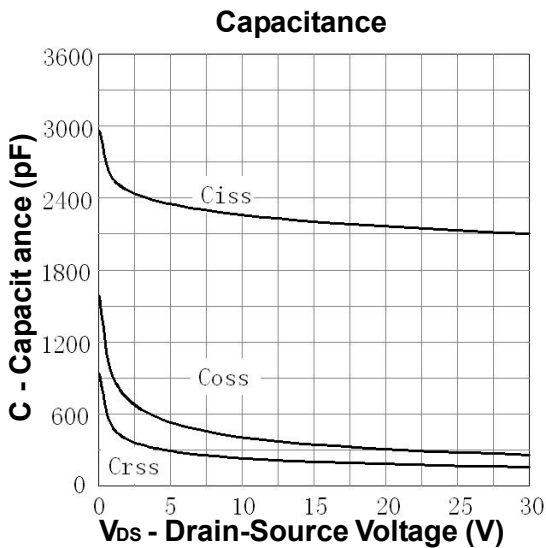
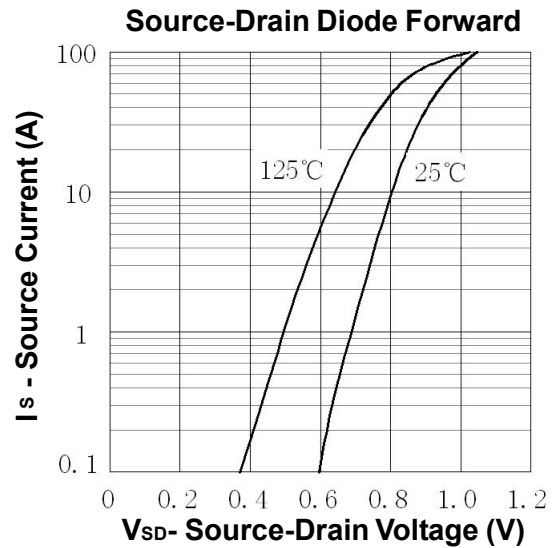
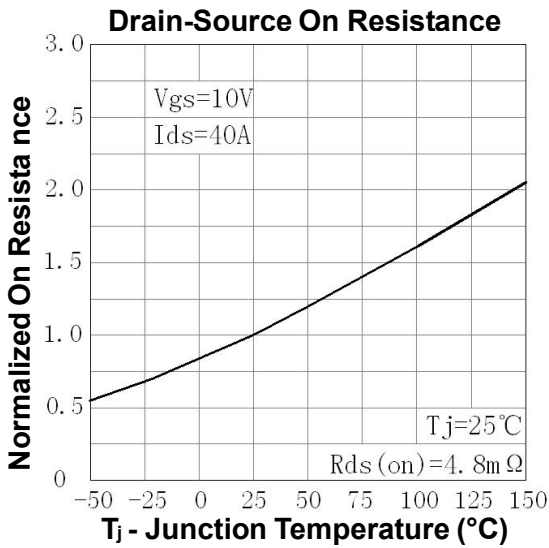
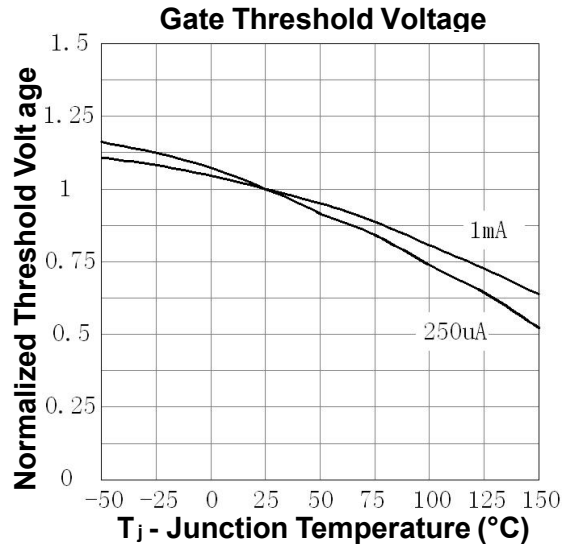
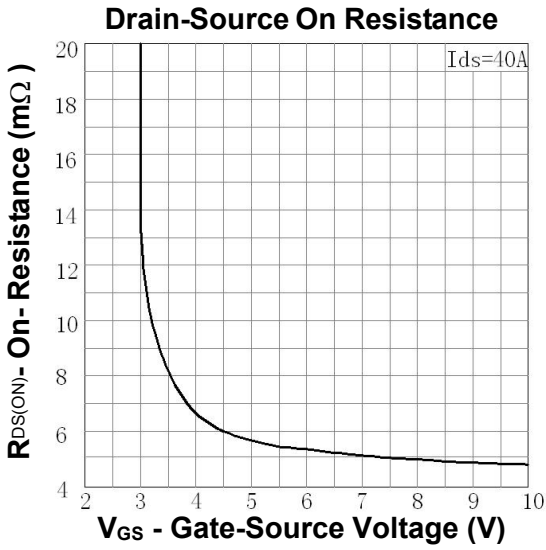

Gate Charge Test Circuit and Waveforms

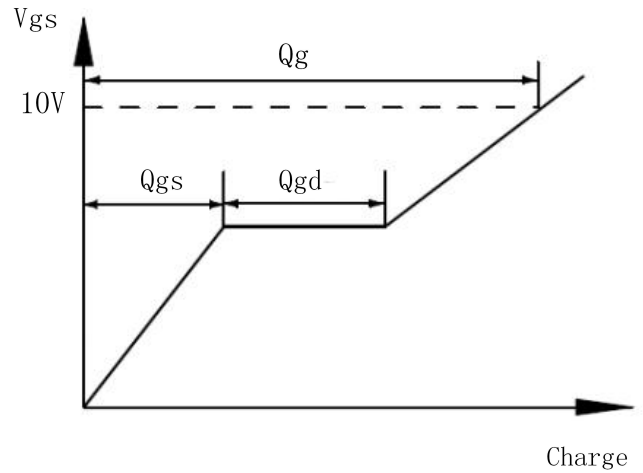
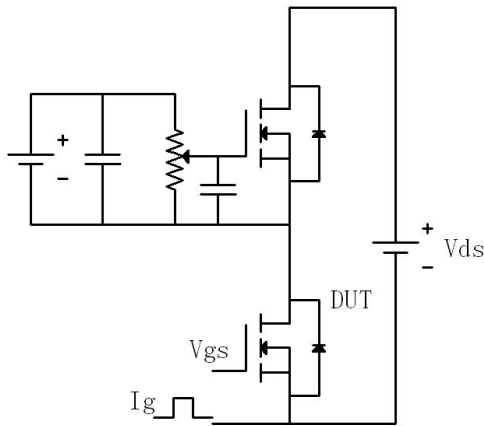

Switching Time Test Circuit & Waveforms

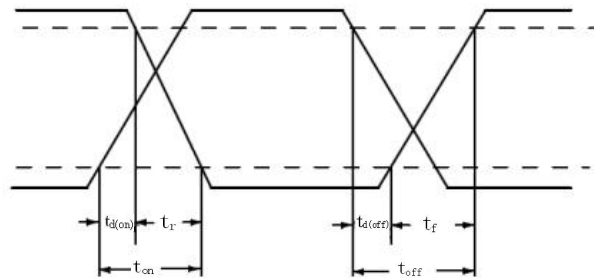
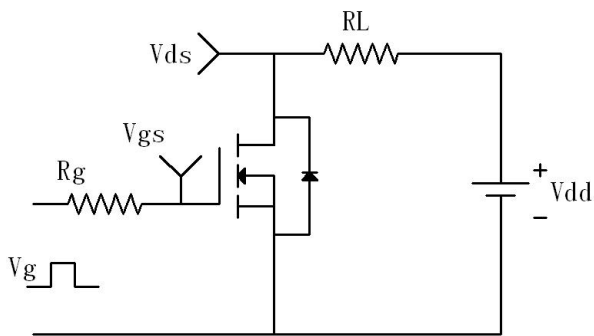

Avalanche Test Circuit & Waveforms

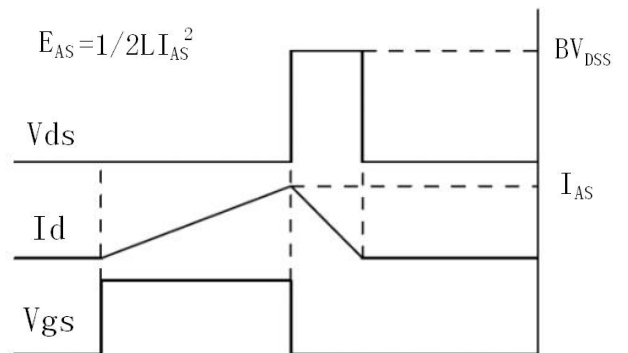
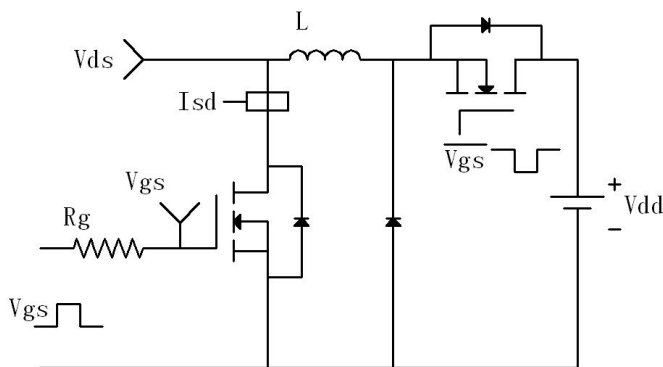

Package Outline

TO252

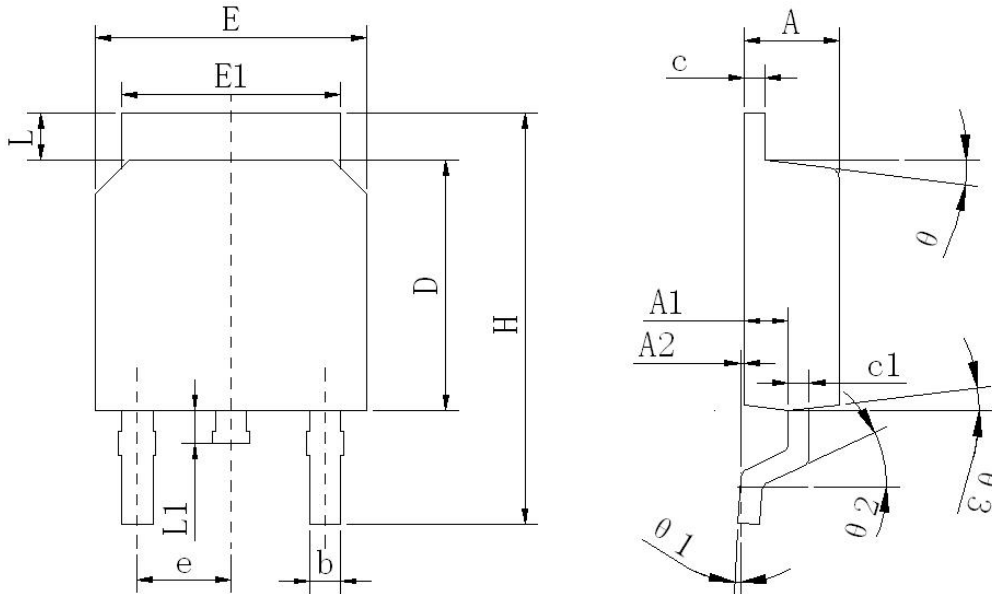

UNIT:mm

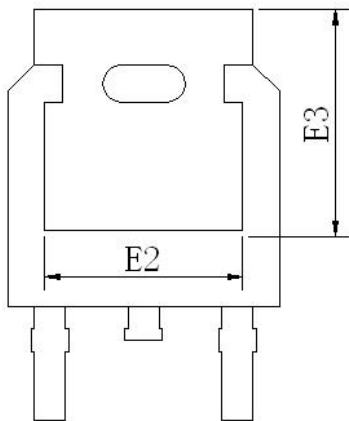

SYMBOL	MIN	NOM	MAX
A	2.25	2.30	2.35
A1	1.02	1.07	1.12
A2	0.05	0.1	0.15
b	0.71	0.76	0.81
c	0.46	0.51	0.56
c1	0.46	0.51	0.56
D	6.05	6.10	6.15
E	6.55	6.60	6.65
E1	5.23	5.33	5.43
E2	4.73	4.83	4.93
E3	5.30	5.40	5.50
e	2.286 BSC		
H	9.82	10.02	10.22
L	0.96	1.01	1.06
L1	0.7	0.8	0.9
θ	5°	7°	9°
θ_1	1°	3°	5°
θ_2	23°	25°	27°
θ_3	5°	7°	9°