

Features

- $V_{DS}=145V, I_D=122A$
Rds(on)(typ)=7.5mΩ@Vgs=10V
- 100% Avalanche Tested
- 100% Rg Tested
- Lead-Free (RoHS Compliant)

Applications

- DC Motor Control
- DC-DC Converters
- BMS
- SMPS
- Automotive Environment

Internal Circuit and Pin Description

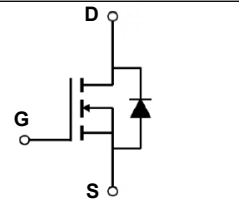
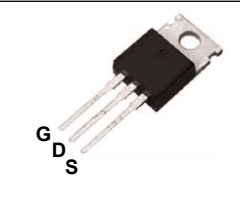
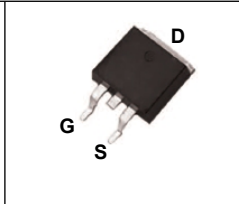
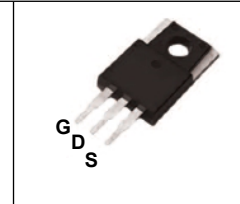
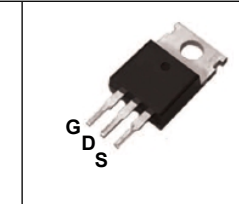
				
Package	TO-220	TO-263	TO-220N	TO-220P
Package Code	R	S	RN	RP

Package Marking

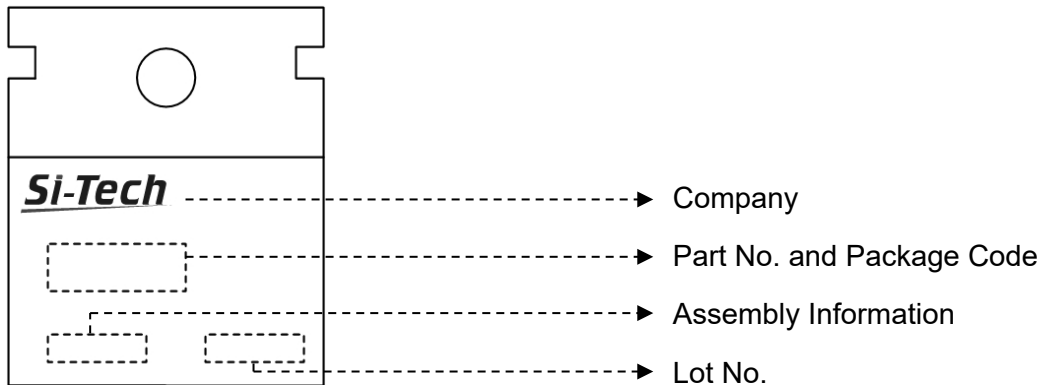

Absolute Maximum Ratings($T_C=25^{\circ}C$ unless otherwise noted)

Symbol	Parameter	Value	Units
V_{DSS}	Drain-Source Voltage	145	V
I_D	Continuous Drain Current ($T_C=25^{\circ}C$)	122	A
	Continuous Drain Current ($T_C=100^{\circ}C$)	77	A
I_{DM}	Pulsed Drain Current (Note 1)	488	A
V_{GS}	Gate-Source Voltage	±25	V
E_{AS}	Single Pulsed Avalanche Energy (Note 2)	666	mJ
P_D	Maximum Power Dissipation ($T_C=25^{\circ}C$)	290	W
	Derating Factor above $25^{\circ}C$	2.32	W/ $^{\circ}C$
T_J	Operating Junction Temperature Range	-55 to +150	$^{\circ}C$
T_{STG}	Storage Temperature Range	-55 to +150	$^{\circ}C$

Thermal Characteristics

Symbol	Parameter	Value	Units
$R_{th\ j-c}$	Thermal Resistance, Junction to case	0.43	$^{\circ}C/W$

Electrical Characteristics ($T_c=25^{\circ}C$ unless otherwise noted)

Symbol	Parameter	Test Conditions	Min.	Typ.	Max.	Units
BV_{DSS}	Drain-Source Breakdown Voltage	$V_{GS}=0V, I_D=250\mu A$	145	-	-	V
I_{DSS}	Drain-Source Leakage Current	$V_{DS}=137V, V_{GS}=0V$	-	-	1	μA
I_{GSS}	Gate Leakage Current, Forward	$V_{GS}=25V, V_{DS}=0V$	-	-	100	nA
	Gate Leakage Current, Reverse	$V_{GS}=-25V, V_{DS}=0V$	-	-	-100	nA
$V_{GS(th)}$	Gate Threshold Voltage	$V_{GS}=V_{DS}, I_D=250\mu A$	2.9	3.5	4.1	V
$R_{DS(on)}$	Drain-Source On-State Resistance	$V_{GS}=10V, I_D=40A$	6	7.5	9	$m\Omega$
Q_g	Total Gate Charge	$V_{DD}=96V$	-	98	-	nC
Q_{gs}	Gate-Source Charge	$V_{GS}=10V$	-	25	-	nC
Q_{gd}	Gate-Drain Charge	$I_D=40A$ (Note 3)	-	38	-	nC
$t_{d(on)}$	Turn-on Delay Time	$V_{DD}=37.5V, V_{GS}=10V$	-	20	-	ns
t_r	Turn-on Rise Time	$I_D=45A, R_G=4.7\Omega$	-	80	-	ns
$t_{d(off)}$	Turn-off Delay Time	$T_c=25^{\circ}C$	-	44	-	ns
t_f	Turn-off Fall Time	(Note 3)	-	41	-	ns
R_g	Gate Resistance	$V_{DS}=0V, V_{GS}=0V, f=1MHz$	-	1.7	-	Ω
C_{iss}	Input Capacitance	$V_{DS}=25V$	-	5018	-	pF
C_{oss}	Output Capacitance	$V_{GS}=0V$	-	749	-	pF
C_{rss}	Reverse Transfer Capacitance	$f = 1MHz$	-	275	-	pF

Source-Drain Diode Characteristics ($T_c=25^{\circ}C$ unless otherwise noted)

Symbol	Parameter	Test Conditions	Min.	Typ.	Max.	Units
I_S	Continuous Source Diode Forward Current		-	-	122	A
I_{SM}	Pulsed Source Diode Forward Current (Note 1)		-	-	488	A
V_{SD}	Forward On Voltage	$V_{GS}=0V, I_S=45A$	-	0.81	1	V
t_{rr}	Reverse Recovery Time	$V_{GS}=0V, I_S=45A$	-	68	-	ns
Q_{rr}	Reverse Recovery Charge	$dI_F/dt = 100A/\mu s$	-	121	-	nC

Notes:

1. Repetitive Rating: Pulse width limited by maximum junction temperature
2. $L=0.5mH, V_{DD}=64V, R_G=25\Omega$, Starting $T_J=25^{\circ}C$
3. Pulse Width $\leq 300\mu s$; Duty Cycle $\leq 2\%$

Typical Characteristics

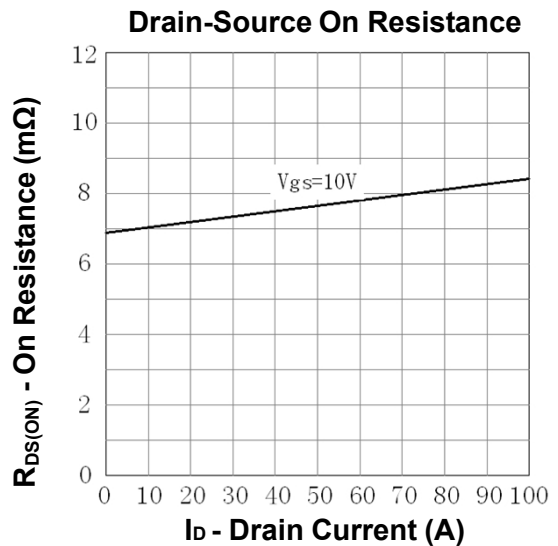
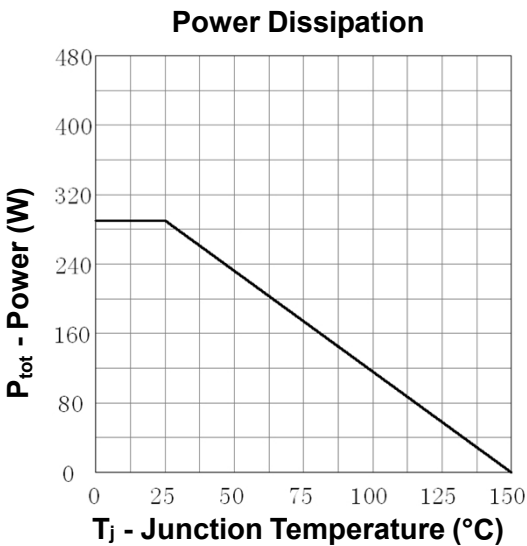
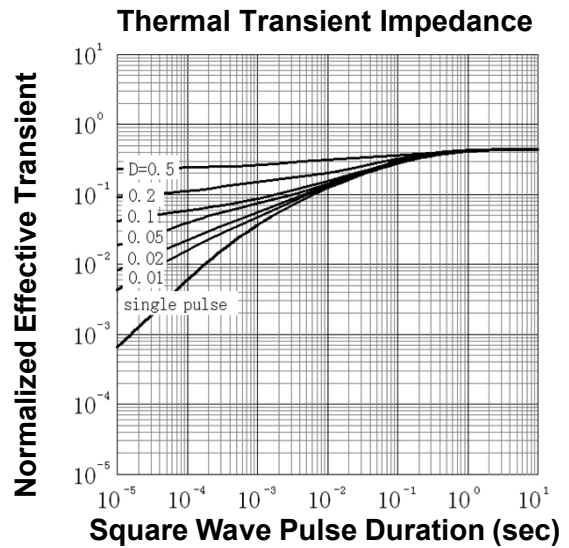
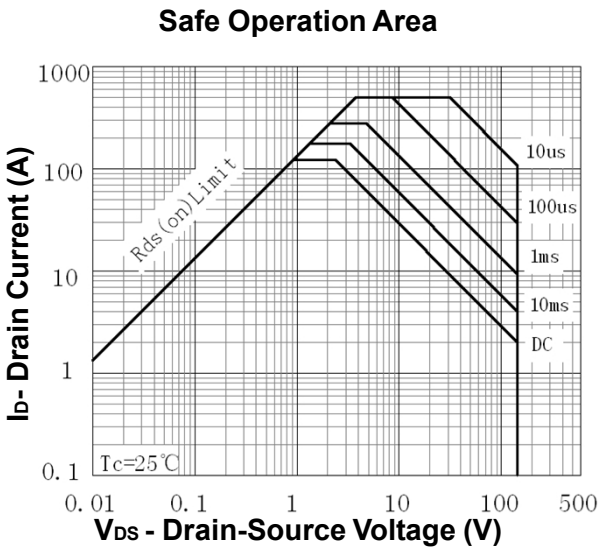
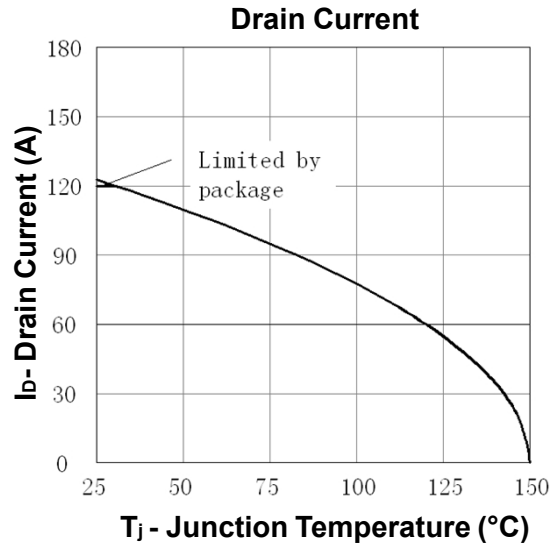
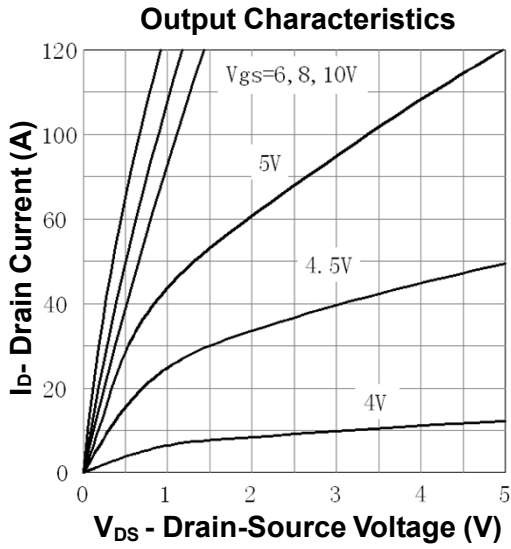

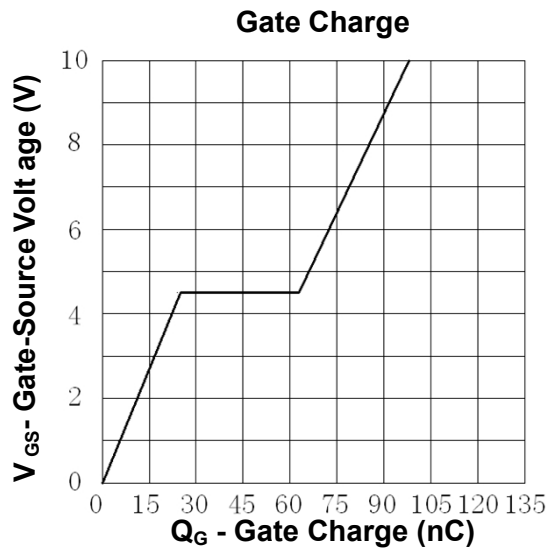
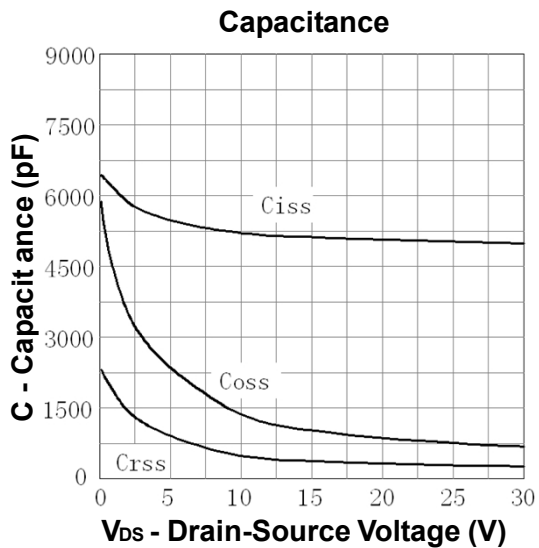
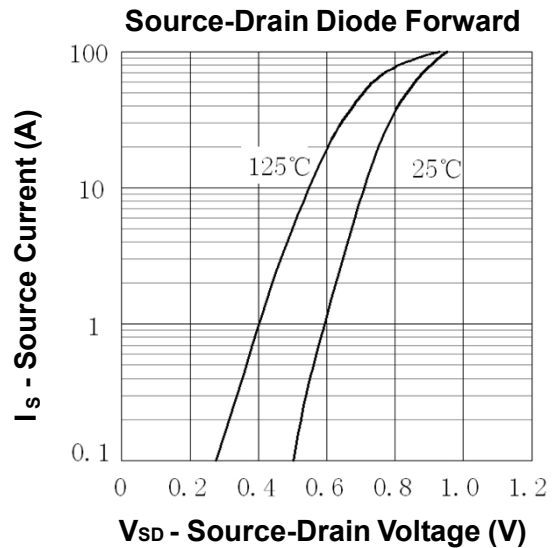
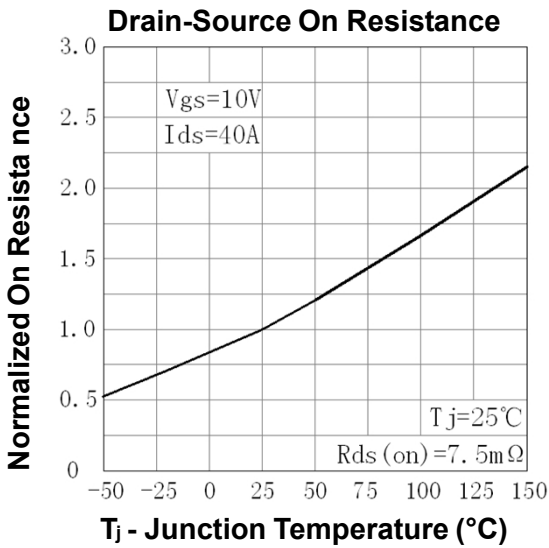
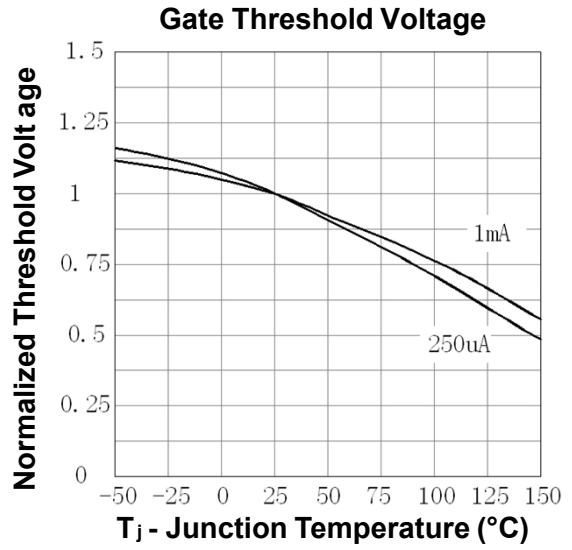
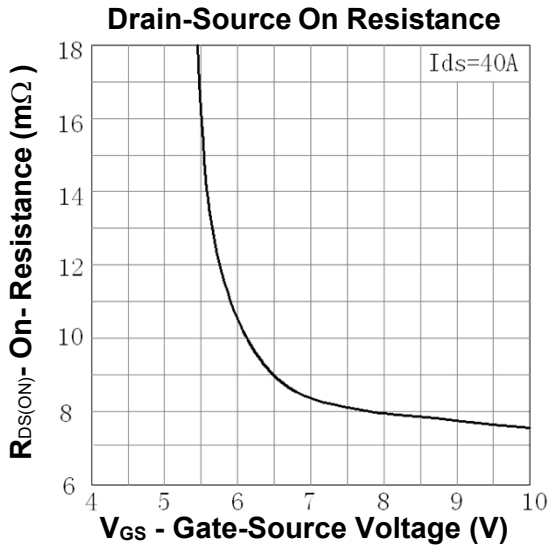

Gate Charge Test Circuit and Waveforms

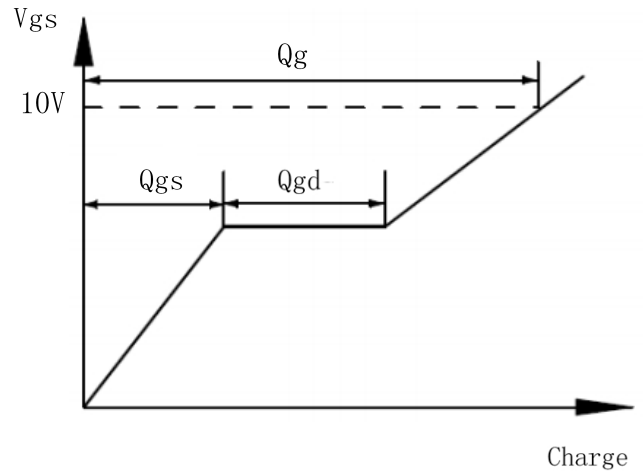
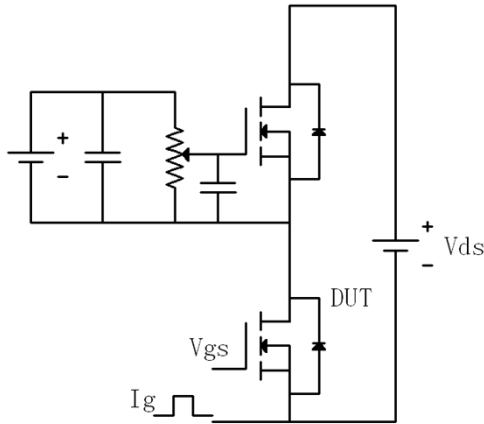

Switching Time Test Circuit & Waveforms

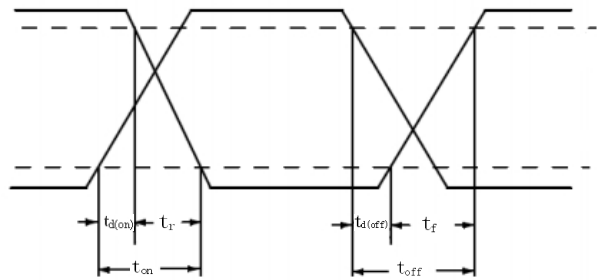
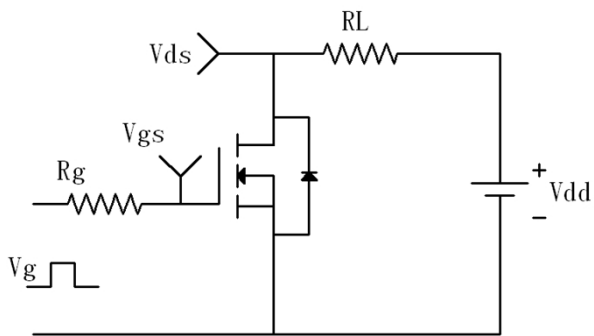

Avalanche Test Circuit & Waveforms

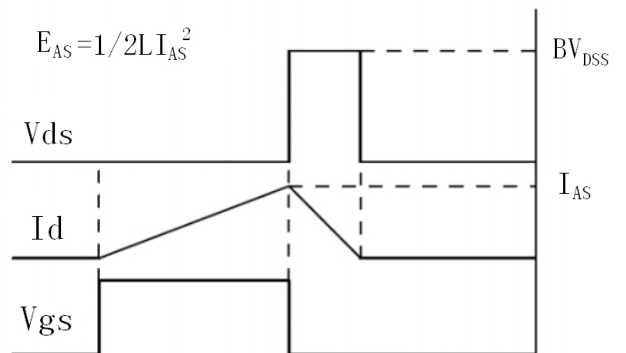
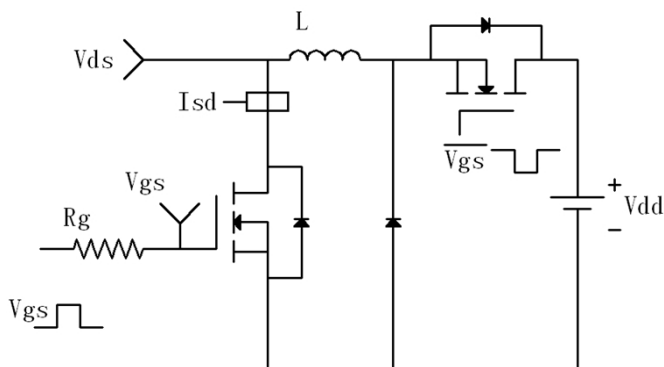

Package Outline

TO220

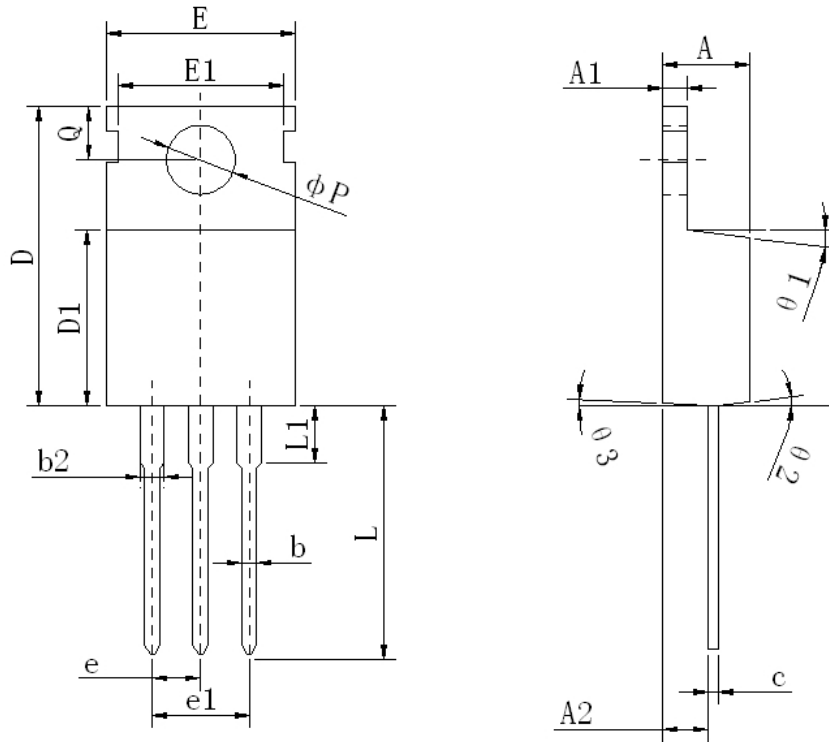

UNIT:mm

SYMBOL	MIN	NOM	MAX
A	4.47	4.57	4.67
A1	1.27	1.30	1.33
A2	2.35	2.40	2.45
b	0.76	0.80	0.89
b2	1.23	1.27	1.38
c	0.47	0.50	0.53
D	15.60	15.70	15.80
D1	9.10	9.20	9.30
E	9.70	9.90	10.10
E1	-	8.70	-
e	2.54 BSC		
e1	5.08 BSC		
L	12.83	13.00	13.17
L1	3.00	3.10	3.20
P	3.57	3.60	3.63
Q	2.75	2.80	2.85
θ1	5°	7°	9°
θ2	1°	3°	5°
θ3	1°	3°	5°

TO263

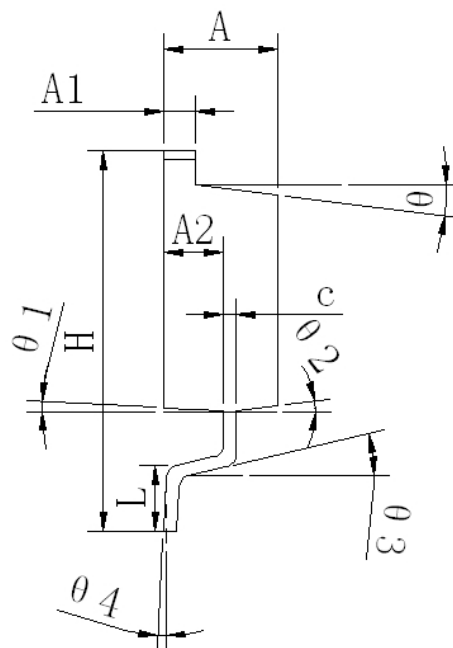
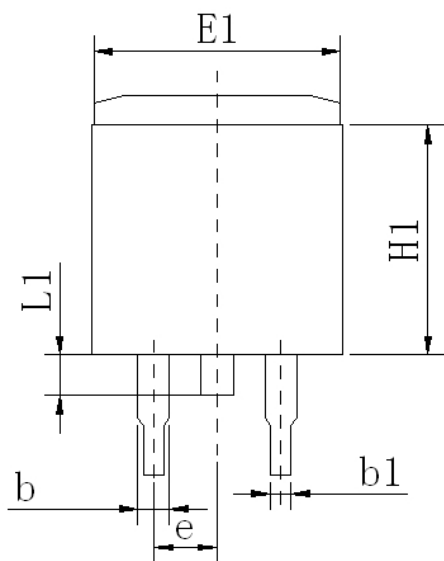

UNIT:mm

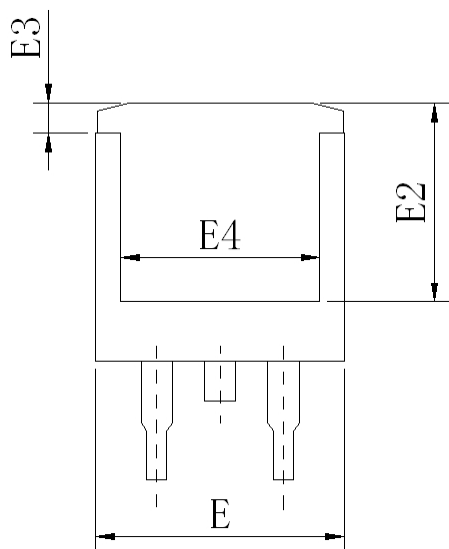

SYMBOL	MIN	NOM	MAX
A	4.47	4.57	4.67
A1	1.25	1.30	1.35
A2	2.34	2.40	2.46
b	1.22	1.27	1.32
b1	0.75	0.80	0.85
c	0.45	0.50	0.55
E	9.90	10.00	10.10
E1	9.78	9.88	9.98
E2	7.95	8.00	8.05
E3	1.10	1.20	1.30
E4	7.95	8.00	8.05
e	2.54 BSC		
H	15.00	15.20	15.40
H1	10.30	10.40	10.50
L	2.20	2.40	2.60
L1	1.50	1.60	1.70
θ	5°	7°	9°
θ1	1°	3°	5°
θ2	5°	7°	9°
θ3	11°	13°	15°
θ4	0°	2°	5°